

solidsteel

Made in Italy since 1990

S5-3 ADVANCED HI-FI RACK

SCALE 1:10

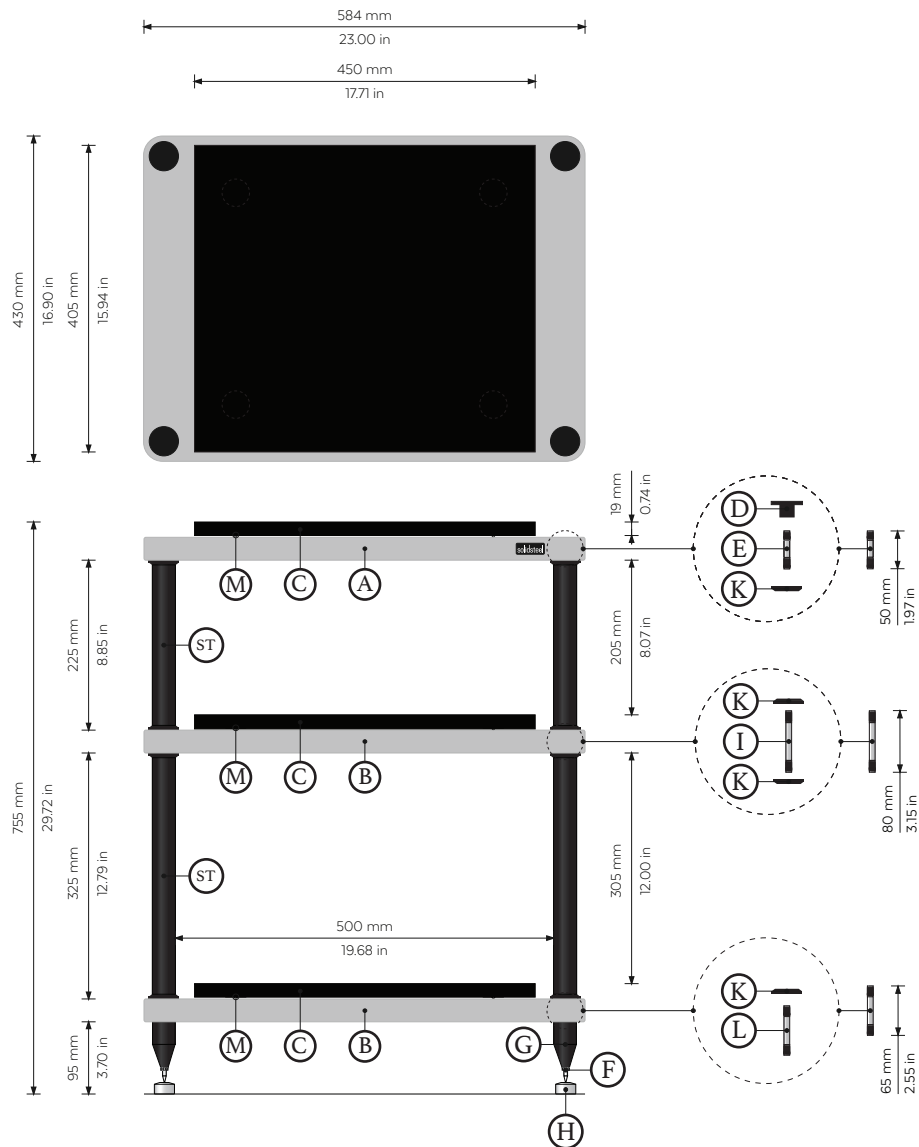

Package Content:

- A) Top Shelf, x1
- B) Inner Shelf, x2
- C) X Plate, x3
- D) Top Covers, x4
- E) Screws for The Top Shelf, x4
- F) Bottom Floor Standing Hardwares, x4

- G) Adjustable Spikes & M8 Nut , x4
- H) Protective Inox Floor Discs, x4
- I) Screws for the Inner Shelf, x4
- K) Connection Discs in ABS, x16
- L) Screws for the Bottom Shelf, x4
- M) Aluminium Cones, x12
- ST) Aluminium Poles, x8

solidsteel

Made in Italy since 1990

S5-3 ADVANCED HI-FI RACK

INSTALLATION

STEP 1

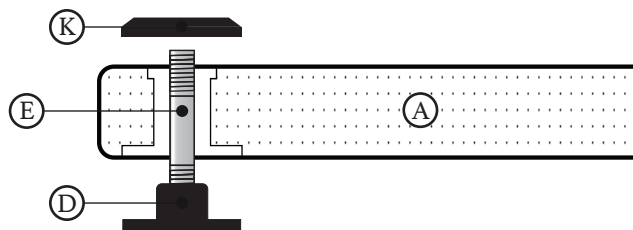

STEP 2

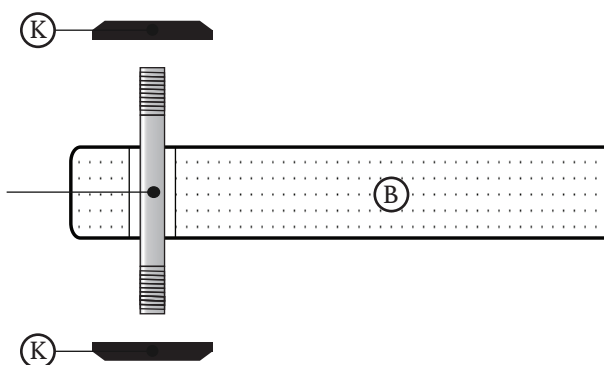

STEP 3

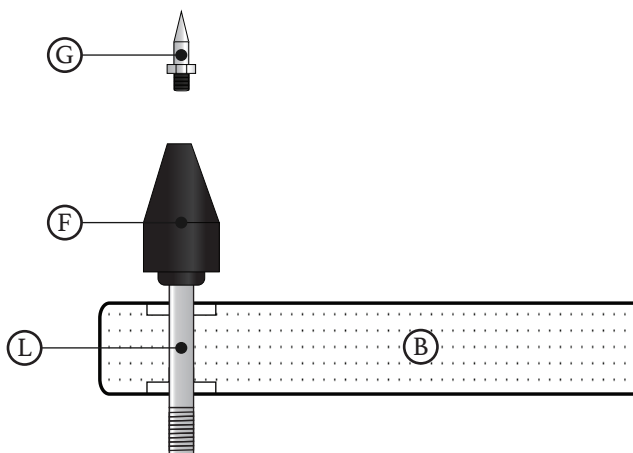

STEP 4 - NOT UPSIDE DOWN!

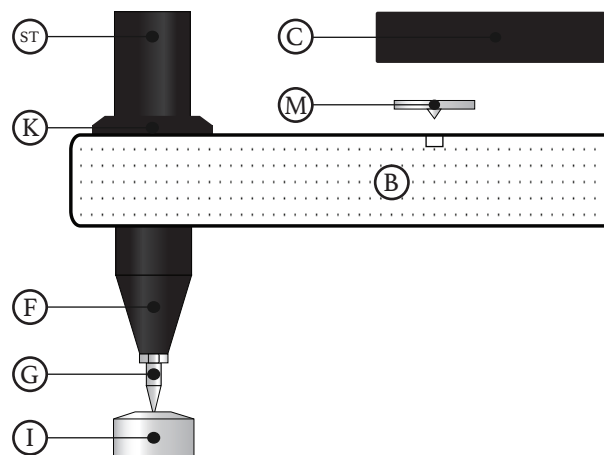

BEFORE STARTING: CONSIDER TO ASSEMBLE ALL THE HARDWARE PARTS UPSIDE DOWN FOR EACH SHELF TO EASY UP THE INSTALLATION. PREPARE A SAFE SURFACE FOR THE OPERATIONS.

Dear Music Lover,
thank you for purchasing one of our S5 Series racks. This product is specifically designed to valorize the enjoyability of your audio experiences and by following this short manual we will guide you through the safe product installation.

Important Recommendations:

- Before the assembly secure an installation zone and keep children, animals and third parts away from all the materials included into the package;
- Some steel parts, if handled without attention, could also be sharp;
- The product can be assembled by a single person but any secondary assistance could be helpful;
- The rack is made by dangerous spikes and hardware parts, so be extremely careful while assembling it. We decline any responsibility for any accidental damage to people, animals or objects;
- Before of assembling the product, find the proper place in which it will be placed. Sliding the product on the floor, during and after its installation, is always dangerous, so never do it;
- During the assembly always grab the shelves and not the hardware parts on them. This is the safest way for handling the product;
- For cleaning the shelves we simply suggest the use of a damp cloth;
- To avoid undesired issues never strike the structure, never give strong shakes and not use the product as if it was a chair;
- The product is only designed to support audio-video components;
- All the shelves are made of painted MDF wood, so gently move the components on them during the installation of your system.

Solidsteel MC Group S.r.l.

Strada Lungofino, 187 - Centro Ibisco
Blocco B1 65013 - Città Sant'Angelo (PE)
ITALY

E-mail: info@solidsteel.it

Website: www.solidsteel.it